

SANTOKA 10.1 BX PCT IPS

Arm® Cortex®-A9 Panel Mount



Product Manual

Document Revision History

The information in this document is subject to change without prior notice in order to improve reliability, design and function and does not represent a commitment on the part of the manufacturer.

Revision	Date	Author	Description
V 1	21.09.2017	CG	Initial Release
V 2	15.03.2018	CG	Page 18 New Picture RS485 Pin 6 to 11
V 3	12.09.2019	CG	Change address
V 4	17.12.2021	bmy	SECO CI Update 2022

Online support on edge.seco.com

Table of Contents

1.	Introduction	4
2.	Safety Hints	5
3.	Product Introduction	7
3.1	Type Plate and Device Information	7
3.2	Product names and variants	8
3.3	Related Documents and Online Support.....	9
4.	Technical Data	10
4.1	Block Diagram SBC	12
4.2	Connectors.....	13
5.	Installation and Start Up	15
5.1	Connection Scheme	15
6.	Internal and External Interfaces	16
6.1	Wi-Fi and Bluetooth Antenna Connectors	16
6.2	Ethernet (X117) (1+2).....	16
6.3	Power (X1).....	17
6.4	CAN/RS-485 Interface (X39).....	18
6.5	USB Host (X34)	19
6.6	USB Host (X113).....	19
6.7	Speaker (X9).....	19
6.8	HDMI (X111)	20
6.9	RS-232/RS-232 (X13).....	21
6.10	USB OTG (X20)	22
6.11	SD Card Slot (X31)	22
6.12	Power LED (D30).....	23
6.13	Bootselect Switch (SW2)	23
6.14	Reset Switch (SW1)	23
6.15	Battery-Holder (X125)	24
6.16	Battery Specifications.....	25
6.17	Replacement of the Internal Battery	26
Annex A:	Technical Drawing	27
Annex B:	Quality and Incoming Inspections	28
B-1	Display and Touch.....	28
Annex C:	Evaluation criteria of standard display module	29
Annex D:	Hardware Revision Information	30
Annex E:	Assembly Options	31
E-1	Wi-Fi / Bluetooth	31
Annex F:	Guidelines and Standards	32
F-1	RoHS Declaration.....	32
F-2	Supplier Declaration – Directive EG 1907/2006 REACH.....	32
F-3	UL Certification.....	32
F-4	SECO Northern Europe Conformity Statement.....	33
Annex G:	Common Documentation	34
G-1	Warranty hints.....	34
G-2	Field of Application.....	35
Annex H:	Technical Support	36
Annex I:	General Information	37

1. Introduction

Thank you very much for purchasing a SECO Northern Europe product. Our products are dedicated to professional use and therefore we suppose extended technical knowledge and practice in working with such products.



The information in this manual is subject to technical changes, particularly as a result of continuous product upgrades. Thus this manual only reflects the technical status of the products at the time of printing. Before design-in the device into your or your customer's product, please verify that this document and the therein described specification is the latest revision and matches to the PCB version. We highly recommend contacting our technical sales team prior to any activity of that kind.

The attached documentation does not entail any guarantee on the part of SECO Northern Europe GmbH with respect to technical processes described in the manual or any product characteristics set out in the manual. We do not accept any liability for any printing errors or other inaccuracies in the manual unless it can be proven that we are aware of such errors or inaccuracies or that we are unaware of these as a result of gross negligence and SECO Northern Europe has failed to eliminate these errors or inaccuracies for this reason. SECO Northern Europe GmbH expressly informs that this manual only contains a general description of technical processes and instructions which may not be applicable in every individual case. In cases of doubt, please contact our technical sales team.

In no event, SECO Northern Europe is liable for any direct, indirect, special, incidental or consequential damages arising out of use or resulting from non-compliance of therein conditions and precautions, even if advised of the possibility of such damages.



Before using a device covered by this document, please carefully read

- ▶ **Annex „G-1 Warranty hints“**
- ▶ **Annex „G-2 Field of Application“**



Embedded systems are complex and sensitive electronic products. Please act carefully and ensure that only qualified personnel will handle and use the device at the stage of development. In the event of damage to the device caused by failure to observe the hints in this manual and on the device (especially the safety instructions), SECO Northern Europe shall not be required to honour the warranty even during the warranty period and shall be exempted from the statutory accident liability obligation. Attempting to repair or modify the product also voids all warranty claims.

2. Safety Hints

Please read this section carefully and observe the instructions for your own safety and correct use of the device. Observe the warnings and instructions on the device and in the manual. SECO Northern Europe embedded systems have been built and tested by us and left the company in a perfectly safe condition. In order to maintain this condition and ensure safe operation, the user must observe the instructions and warnings contained in this manual.



I. General Handling

- ▶ Don't drop or strike the unit: The PCB, display and/or other parts might be damaged.
- ▶ Keep away from water and other liquids, the unit is not protected against.
- ▶ Operate the unit under electrical and environmental conditions according to the technical specification.
- ▶ The electrical installations in the room must correspond to the requirements of the local (country-specific) regulations.
- ▶ Take care that there are no cables, particularly power cables, in areas where persons can trip over them.
- ▶ Do not place the device in direct sunlight, near heat sources or in a damp place.
- ▶ All plugs on the connection cables must be screwed or locked to the housing.
- ▶ Repairs may only be carried out by qualified specialist personnel authorized by SECO Northern Europe GmbH or their local distributors.
- ▶ Maintenance or repair on the open device may only be carried out by qualified personnel authorized by SECO Northern Europe GmbH which is aware of with the associated dangers.



II. Electricity

- ▶ The embedded systems may only be opened in accordance with the description in this user's manual for
 - replacing of the (rechargeable, where applicable) lithium battery and/or
 - configuration of interfaces, where applicable
- ▶ These procedures have to be carried-out only by qualified specialist personnel.
- ▶ When accessing internal components the device must be switched off and disconnected from the power source.
- ▶ When purchased core or basic versions without protecting back cover, don't touch the PCB directly with your fingers. Especially these products need to be handled very carefully.
- ▶ Don't operate or handle the unit without typical ESD protection measures, such as ground earthing.
- ▶ Operate the unit according to the technical specification only.



III. Damage or Permanent Malfunction

- ▶ It must be assumed that a safe operation is no longer possible, in case
 - the device has visible damage or
 - the display is dark or shows strange pattern for longer period
 - the device doesn't react after a reset
- ▶ In these cases the device must be shut down and secured against further use



IV. Approvals

- ▶ The SANTOKA may be equipped with a certified transmitting module.
- ▶ The internal / external antenna(s) used for this module must provide a separation distance of at least 2 cm from all persons and must not be co-located or operating in conjunction with any other antenna or transmitter.
The outside of final products containing the SANTOKA module must display in a user accessible area a label referring to the enclosed transmitting module. This exterior label can use wording such as the following¹²: “Contains Transmitter Module FCC ID: *(insert the modules FCC ID)*” or “Contains FCC ID: *(insert the modules FCC ID)*”.
- ▶ Approved antennas list: For the WLAN/Bluetooth module WPEA-152GN(BT) a dipole antenna with 2 dBi (peak) gain is approved

V. FCC

- ▶ To comply with FCC and Industry Canada RF exposure limits for general population / uncontrolled exposure, the antenna(s) used for this transmitter must be installed to provide a separation distance of at least 2 cm from all persons and operating in conjunction with any other antenna or transmitter, except in accordance with FCC multi-transmitter product procedures

3. Product Introduction

This document is applicable for hardware revisions 1.0 or later of the SANTOKA series.

Please find the hardware version grid in „**Annex D: Hardware Revision Information**“:



SANTOKA is an Embedded System to be used as human machine interface (HMI) in various applications. Please refer to **Annex „G-2 Field of Application“** for further information. The system is equipped with a large number of industrial interfaces. A wide variety of options is available as well.

3.1 Type Plate and Device Information

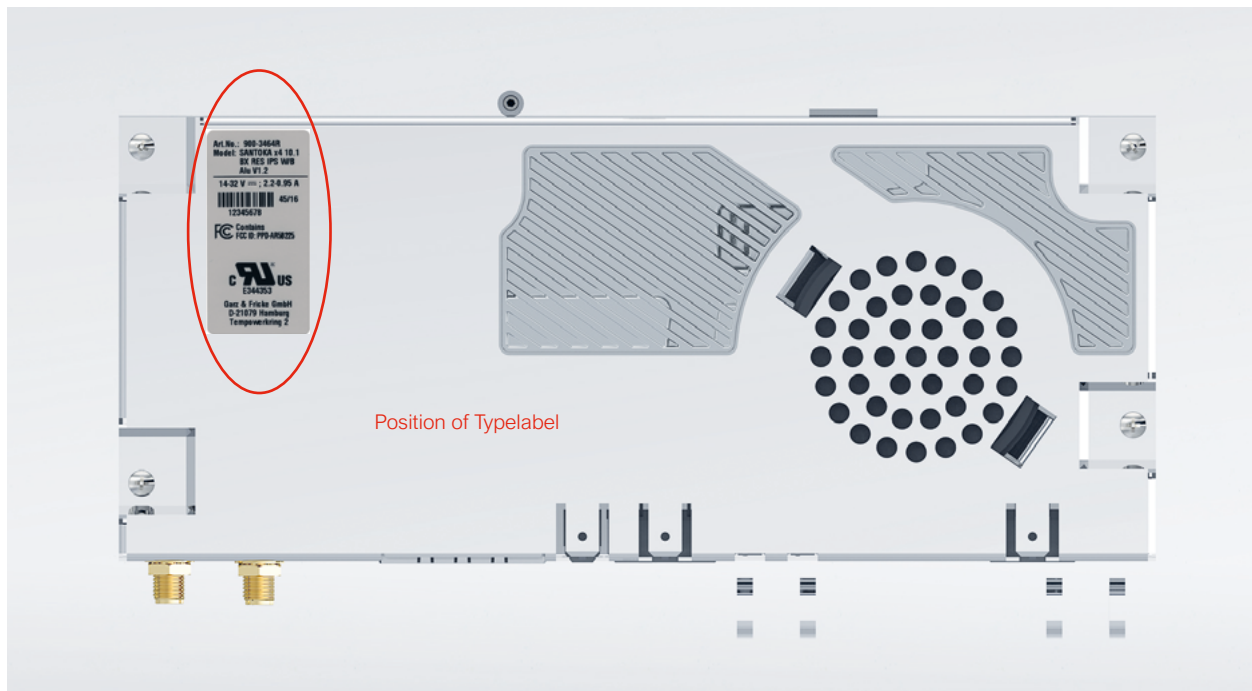
For service and later identification of the device, the type plate contains important information.



(Exemplary Illustration (cutout) backside)

Art.No.: 900-3464R	SECO Northern Europe article number
Model: SANTOKA x4 10.1 BX RES IPS W/B Alu V1.2	Product name and configuration
14-32 V ~ ; 2.2-0.95 A	Power ratings
 45/16	Production date (week/year)
12345678	Serial number
FC Contains FCC ID: PPD-AR58225	Placeholder for additional test marks and approvals
 E344353	UL approval
Garz & Fricke GmbH D-21079 Hamburg Tempowerkring 2	Manufakturer name and address

3.2 Product names and variants

Product name definition:

SANTOKA <CPU> <7.0> <BX> <PCT> <IPS> <additional description> <Vx.y.z>

Explanation:

SANTOKA	Product family name (invariable)
<CPU> x1, x2, x2I, x4, x4P	(number of cores inside the i.MX6 processor)
<7.0>	Display size in inch
<BX>, <SG>, <OF>	mechanical design of enclosure
<PCT>, <RES>	projected capacitive touch; if blank: 4-wire resistive / resistive touch
<IPS>	Display technology "in-plane switching", (option)
<additional description>	contains variants which are important to sales product description, i.e.
	<ul style="list-style-type: none"> ▶ without or with WLAN/Bluetooth module ("W/B") ▶ untreated glass surface or including antiglare treatment ("AG") ▶ front frame made from die-cast zinc or aluminium ("Alu") ▶ different memory capacities for RAM and/or eMMC ▶ customer-specific reduced assembly ▶ etc.
<Vx.y.z>	revision of PCB layout
<x>	describes major changes in form fit and functions
<y>	describes variants that are different in PCB layout and could affect the list of critical components (UL LoCC).
<z>	describes minor changes to PCB layout due to production optimization like solder resist mask or drilling diameters. Also minor changes in assembly of PCB and/or device which do NOT affect the list of critical components (UL LoCC) due to unlisted components or declared "interchangeable".

3.3 Related Documents and Online Support

This document contains operating system specific information. The following additional documentations are available:

OPERATING SYSTEMS

Linux Yocto Jethro	 https://bit.ly/3lwp6an	Contains information about Linux BSP with development environment Linux Embedded System Yocto (Codename: Jethro, Version 3.0) includes first information about the bootloader Flash-N-Go
Linux Yocto Rocko	 https://bit.ly/3puByZA	
Android 7.1	 https://bit.ly/32XoCni	

UPDATE / BOOT / SYSTEM

Flash-N-Go	 https://bit.ly/3xPzoHy	Contains information about the usage of the G&F Flash-N-Go solution which consists of three submodules: <ul style="list-style-type: none"> ▶ Flash-N-Go Boot (A tiny boot loader) ▶ Flash-N-Go System (A maintenance os) ▶ Flash-N-Go Update (A GUI based update solution for all os)
------------	--	--

4. Technical Data

CPU	x1	x2	x4	x4P
CPU Type	i.MX6Solo	i.MX6Dual	i.MX6Quad	i.MX6QuadPlus
Core Class	Arm® Cortex®-A9			
Core Clock	1 GHz			
Features	NEON for SIMD media acceleration and VFP operations; Multi-format HD 1080p video decoder and HD 720p video encoder hardware engine; L1 cache, 32 KB for instruction, 32 KB for data			
	512 KB L2 cache	1 MB L2 cache		
HW Accelerators	OpenGL ES 2.0, OpenVG 1.1			
RTC	Accuracy: +/- 30 ppm at 25°C			
Memory				
eMMC Flash	4 GB MLC eMMC			8 GB MLC eMMC
RAM Standard	1 GB 32 bit DDR3L	1 GB 64 bit DDR3L		4 GB 64 bit DDR3L
SD Card Slot	4 bit MMC/SDIO/SD/SDHC			
Operating Systems				
Supported OS	Linux Yocto Jethro			
Communication Interfaces				
Network	2x 10/100 Mbit/s Ethernet (RJ-45)			
USB 2.0	2x 480 Mbit/s Host (Type A) 1x 480 Mbit/s OTG (Type Micro-AB) ¹			
CAN Fieldbus / RS-485	1x CAN (ISO/DIS 11898) + 1x RS-485	1x CAN (ISO/DIS 11898) + 1x RS-485 galvanic isolated		
RS-232	2x RS-232 (RX/TX/CTS/RTS)			
	MDB ² / 1x MDB (Master / Slave optional) ³ instead of 2nd external RS-232			
Synchronous Serial Interfaces	SPI up to 12 chip selects; I ² C; Matrix keypad up to 8 x 8			
Wireless Communication				
Wireless	WLAN 802.11 b/g/n; Bluetooth 4.0 LE / available as optional mPCIe card			
Video				
Video output	Full HD HDMI			
Audio				
Speaker output	1x speaker (connector), 1.5 W RMS (8Ω)			
Audio Internal	1x speaker 0.3 W RMS (8Ω)			
Display and Touch				
Size	10.1 inch / 256.54 mm			
Resolution	1280 x 800 pixel			
Brightness	Typ. 420 cd/m ²			
Backlight Lifetime	Typ. 50.000 h			
Viewing Angle	85°, 85°, 85°, 85°(UDRL)			
Color	24 bit (16.7 Mio. colors)			
Touch	projected capacitive multitouch			

¹ Mechanically the Micro-USB interface has not been designed for frequent contact operations. Please use an adapter cable with a strain relief.

² Option

³ The selection of a variant eliminates the other.

Housing	x1	x2	x4	x4P
Front	3.0 mm toughened glass, RAL 9005			
Frame	Fine zinc alloy, matt chrome			
Rear	1.4016 stainless steel, foam seal			
Ingress Protection	Front IP 66/Rear IP20			
Device Dimensions				
W x H x D	275.2 x 192.0 x 37.9 mm			
Weight	tbd.			
Power Supply				
Supply Voltage	Nom. 13 to 32 V DC			
Consumption	Typ. 9.8 W; max. 32.6 W			
Internal Backup Battery (RTC)	Type: 3 V Lithium battery Type CR1220: Lifetime (RTC only): Approximately 8 years, depending on application			
Typical Environmental Conditions				
Storage Temp.	-20 to +70 °C			
Operating Temp.	0 to +60 °C			
Humidity	5 to 90 % RH			
Max. Operating Altitude	3.000 m			
Max. Storage/Transit Altitude	10.000 m			
Noise Level [db(A)] @ 1m	<<40 (fanless design)			
Lifetime				
MTBF	≥ 400.000 h			
Expansion Slot				
PCIe	PCIe Mini connector (for half size card)			

4.1 Block Diagram SBC

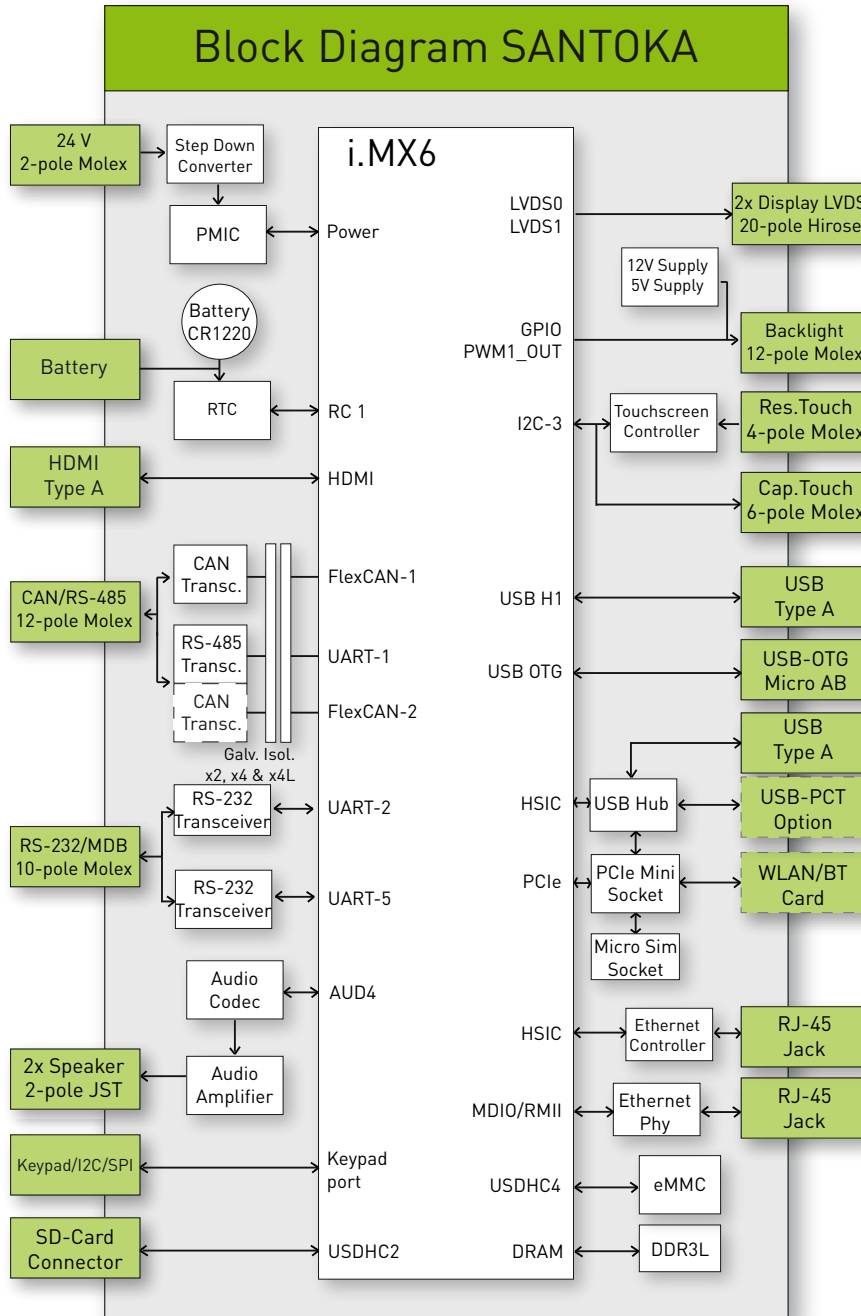

4.2 Connectors

As this manual describes a boxed version, only the external interfaces will be mentioned in the following chapter.

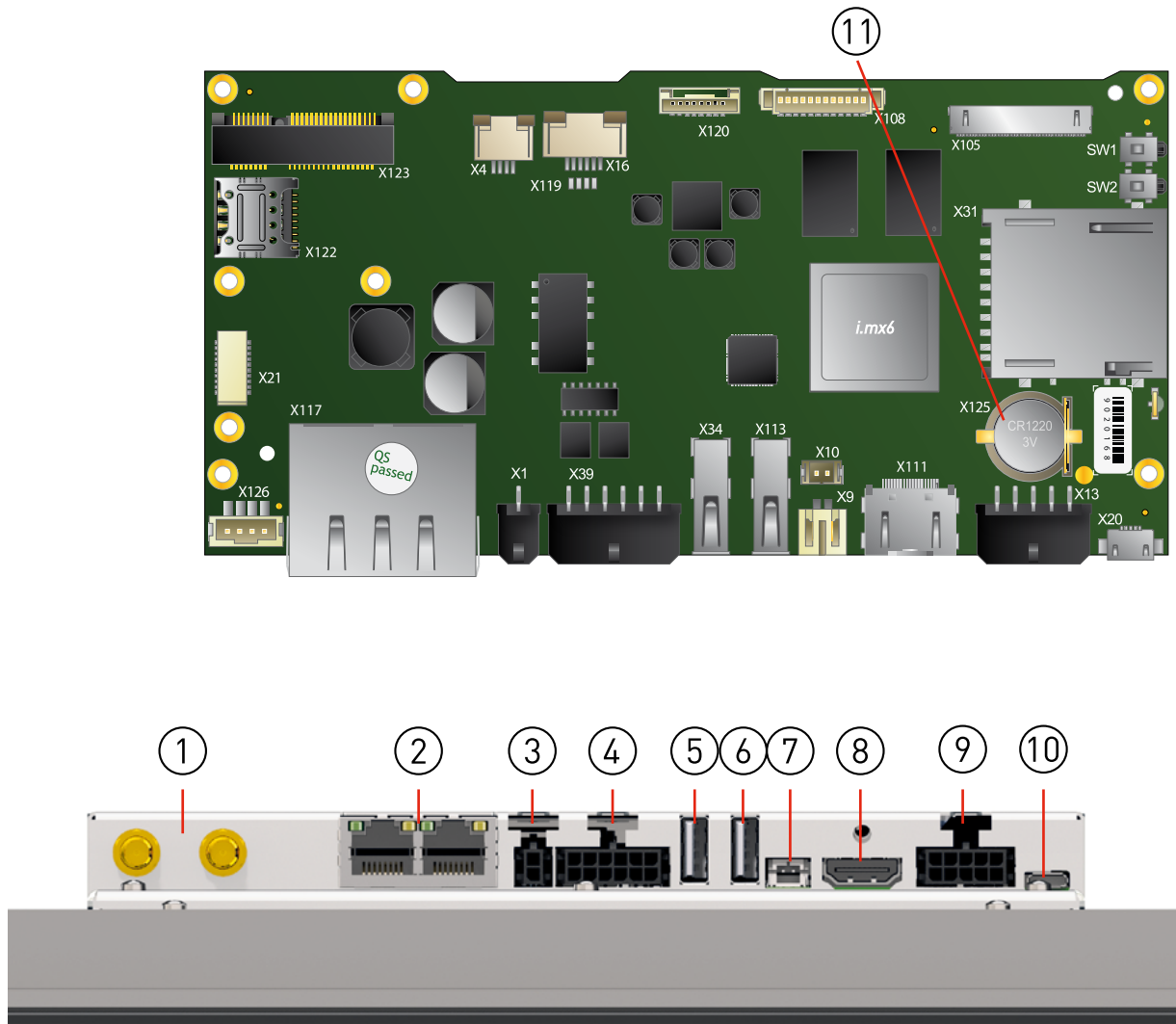

(Exemplary Illustration. It shows a cutout of the fully equipped SANTOKA)

Pos.	Description
1	Wi-Fi/Bluetooth Antena connectors
2	Ethernet (X117 1+2)
3	Power (X1)
4	CAN/RS-485 Interface (X39) Optional with galvanic isolation
5	USB Host (X34)
6	USB Host (X113)
7	Speaker (X9)
8	HDMI (X111)
9	RS-232/MDB (X13)
10	USB OTG (X20)
11	Battery (X125)

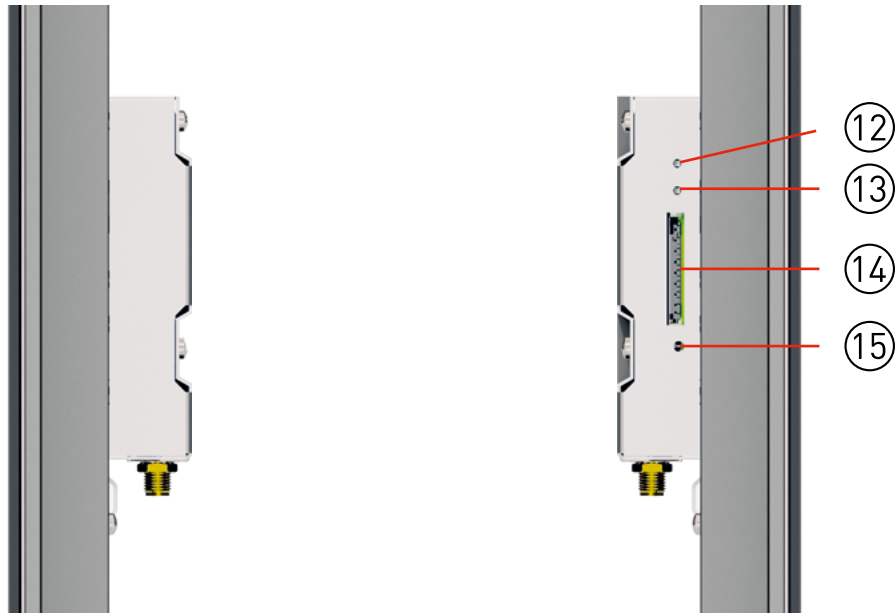

(Exemplary Illustration (cutout) both sides)

Pos.	Description
12	Reset Switch (SW1)
13	Bootselect Switch (SW2) ¹
14	SD card slot (X31)
15	Power LED (D30)

¹ For the function of this switch please refer to the Flash N Go User Manual.

5. Installation and Start Up

The content of this document is limited to explain the device connectors and how to access SANTOKA via FTP over your local area network (LAN) within a few seconds. For advanced hardware specifications and software support, please refer to chapter „3.3 Related Documents and Online Support“

5.1 Connection Scheme

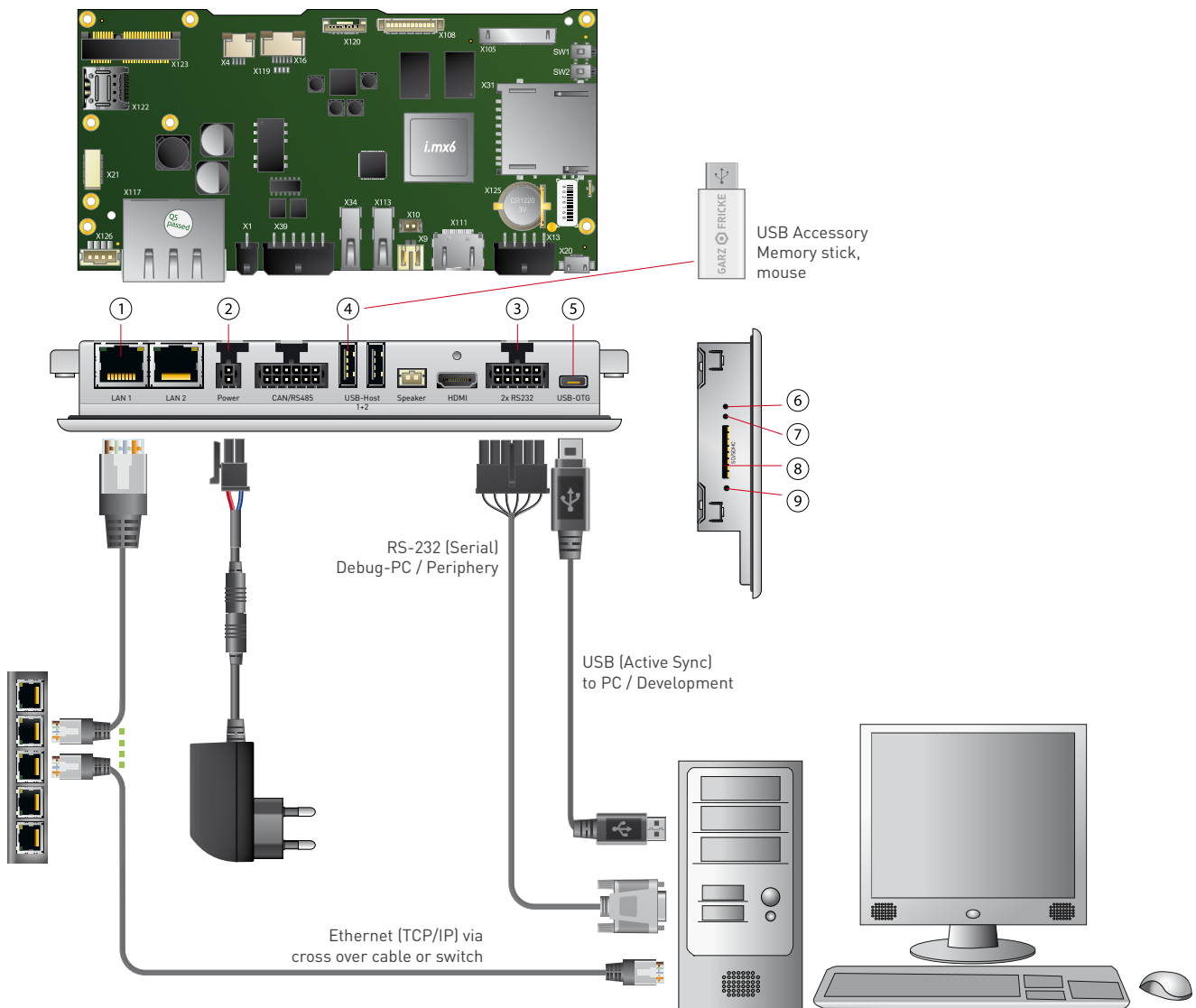

Exemplary Illustration

Pos.	Description
1	Ethernet
2	DC in
3	RS-232
4	USB Device
5	USB Host (OTG)

Pos.	Description
6	Reset sw
7	Bootselect sw
8	SD card slot
9	Power LED



<http://support.garz-fricke.com/projects/Santoka/>

6. Internal and External Interfaces

6.1 Wi-Fi and Bluetooth Antenna Connectors



- 1 Wi-Fi connector
- 2 Bluetooth connector

Header: SMA (RP-SMA optional)

6.2 Ethernet (X117) (1+2)

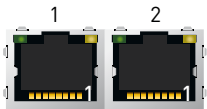

Pin	Name	Description	Information
1	Tx+		Rx/Tx might be swapped (Auto-MDIX) +/- might be swapped (Autom. polarity correction)
2	TX-		
3	RX+		
4	SPARE 1		
5			
6	RX-		
7	SPARE 2		
8			

Header: RJ45

Green LED (link) is default off and turns on when link is detected.

Yellow LED (act) flashes during sending/receiving packets.

6.3 Power (X1)



Pin	Name	Description	Level
1	GND	DC Ground	0 V
2	Vcc_In	DC Input voltage	Nom. 9 to 32 V DC

Header: Molex 43045-0200 Micro-Fit 2p
 Plug: Molex 43025-0200 Micro-Fit 2p,
 crimp contact Molex 43030-0007
 Shielding with 6,3 mm male spade terminal connector.



Caution:
 Power supplies connected to this device must be compliant to the requirements of
 “limited power sources” (LPS) to prevent the end-user from danger in case of a fault.

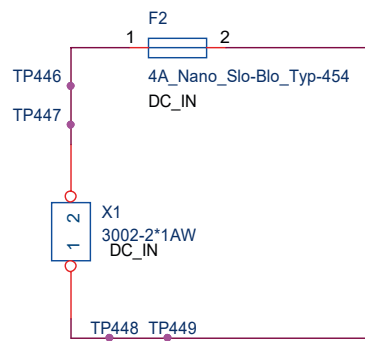

6.4 CAN/RS-485 Interface (X39)

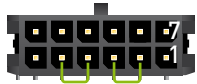
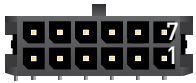

CAN1 Termination

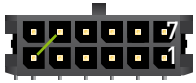

RS485 Termination

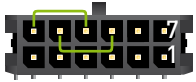

RS485 Half-Duplex

Pin	Name	Description	Level	
1	GND_CAN_RS485	Ground for CAN and RS485 group		
2	CAN1_TERM	To enable CAN1-Termination, bridge with CAN1_H		
3	CAN1_H	CAN bus 1 high	-24	+24 V
4	CAN1_L	CAN bus 1 low	-24	+24 V
5	CAN1_TERM	To enable CAN1-Termination, bridge with CAN1_L		
6	RS485_TERM	To enable RS485-Termination: bridge with RS485_A		
7	GND_CAN_RS485	Ground for CAN and RS485 group		
8	n.a.			
9	RS485_Y	TX+	-7	+12 V
10	RS485_Z	TX-	-7	+12 V
11	RS485_A	RX+, to enable Half-Duplex: bridge with RS485_Y		
12	RS485_B	RX-, to enable Half-Duplex: bridge with RS485_Z		

Header: Molex 43045-1200 Micro-Fit 12p

Plug: Molex 43025-1200 Micro-Fit 12p, crimp contact Molex 43030-0007

Shielding with 6,3 mm male spade terminal connector

CAN1 / CAN2 *

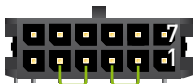
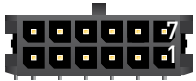

CAN1 Termination

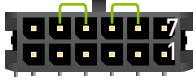

CAN2 Termination

Pin	Name	Description	Level	
1-5		Identical to standard		
6	n.a.			
7	GND_CAN_RS485	Ground for CAN group		
8	CAN2_TERM	To enable CAN2-Termination, bridge with CAN2_H		
9	CAN2_H	CAN bus 2 high	-24	+24 V
10	CAN2_L	CAN bus 2 low	-24	+24 V
11	CAN2_TERM	To enable CAN2-Termination, bridge with CAN2_L		
12	n.a.			

* alternative assembly upon request

6.5 USB Host (X34)



Pin	Name	Description	Level
1	USB_H1_VBUS	Power supply	+5 V DC max 500mA
2	USB_H1_DN	Data minus (D-)	
3	USB_H1_DP	Data plus (D+)	
4	GND	Ground	

Header: USB Type A

6.6 USB Host (X113)



Pin	Name	Description	Level
1	USB_H1_VBUS	Power supply	+5 V DC max 500mA
2	USB_H1_DN	Data minus (D-)	
3	USB_H1_DP	Data plus (D+)	
4	GND	Ground	

Header: USB Type A

6.7 Speaker (X9)



Pin	Name	Description	Level
1	Speaker +	Parallel to X10	1.5W RMS 8 Ohm
2	Speaker -		

Header: JST S2B-PH-SM3-TB

Plug: ST PHR-2 with crimp contacts SPH-002GW-P0.5L-ND

6.8 HDMI (X111)

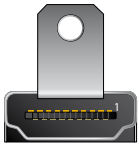

Pin	Name	Description	Level
1	D2 +	TMDS Data2+	
2	GND	TMDS Data2 shield	
3	D2 -	TMDS Data2-	
4	D1 +	TMDS Data1+	
5	GND	TMDS Data1 shield	
6	D1 -	TMDS Data1-	
7	D0 +	TMDS Data0+	
8	GND	TMDS Data0 shield	
9	D0-	TMDS Data0-	
10	CK +	TMDS Clock+	
11	GND	TMDS Clock schirm	
12	CK -	TMDS Clock-	
13	CEC	CEC	
14	Utility	NC	
15	I2C_CLK	SCL (I ² C serial clock for DDC)	
16	I2C_Data	SDA (I ² C serial data for DDC)	
17	DDC/CEC_GND	DDC/CEC/HEC - Masse	
18	+ 5 V	Supply	+ 5 V max. 55 mA
19	HOT_PLUG_DETECT	Hot - Plug - Detect	

Header: HDMI Type - A

6.9 RS-232/RS-232 (X13)

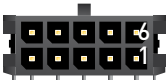

Pin	Name	Description	Level
1	GND	Ground	
2	RS232_TXD1	Port#1: Transmit data (Output)	
3	RS232_RXD1	Port#1: Receive data (Input)	
4	RS232_RTS1	Port#1: Request-to-send (Output)	
5	RS232_CTS1	Port#1: Clear-to-send (Input)	
6	GND	Ground	
7	RS232_TXD2	Port#2: Transmit data (Output)	
8	RS232_RXD2	Port#2: Receive data (Input)	
9	RS232_RTS2	Port#2: Request-to-send (Output)	
10	RS232_CTS2	Port#2: Clear-to-send (Input)	

Header: Molex 43045-1000 Micro-Fit 10p
 Plug: Molex 43025-1000 Micro-Fit 10p,
 crimp contact Molex 43030-0007
 Shielding with 6,3 mm male spade terminal connector

RS-232/MDB *



Pin	Name	Description	Level
1-6		Identical to standard	
7	MDB_TXD	MDB: Transmit data (Output)	
8	MDB_RXD2	MDB: Receive data (Input)	
9	MDB_WakeUp	MDB: WakeUp Signal (Output)	
10		MDB: WakeUp PullUp VCC	0.5 V

* alternative assembly upon request

6.10 USB OTG (X20)



Pin	Name	Description	Level
1	USB_OTG_VBUS	Power supply	+5 V DC max 500mA
2	USB_OTG_DN	Data minus (D-)	
3	USB_OTG_DP	Data plus (D+)	
4	USB_OTG_ID	Device ID	
5	GND	Ground	

Header: Micro-USB Type AB

6.11 SD Card Slot (X31)

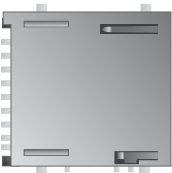

Pin	Name	Description	Level
1	DAT3		
2	CMD	Pullup	3.3 V
3	GND		
4	VDD		3.3 V
5	CLK		
6	GND		
7	DAT0		
8	DAT1		
9	DAT2		

6.12 Power LED (D30)

Should be green if the device is powered up.

6.13 Bootselect Switch (SW2)

Push during a power on sequence to boot into the secondary OS.

6.14 Reset Switch (SW1)

Push for a power on reset.

6.15 Battery-Holder (X125)



Pin	Name	Description	Level
1	VCC	Supply	3 V
2	GND	Ground	

Header: AUK BH19VWG-R5H-H
 Battery: CR2032

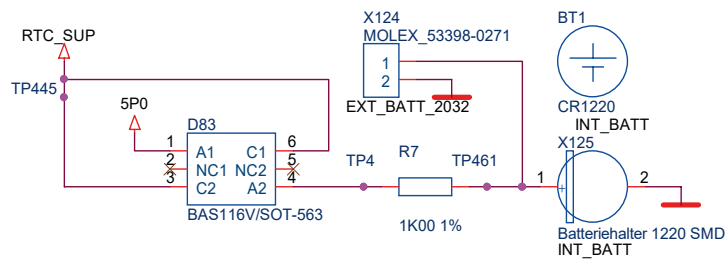

Battery

6.16 Battery Specifications

The internal baseboard is equipped with a Primary Lithium battery (type CR1220), which has a typical lifetime of 8 years.

Type	SECO Northern Europe Article Number
Battery type CR1220	010-0059R

Manufacturer	Model
Varta	CR1220
Alpha 3 Manufacturing Ltd.	YOBCR1220
Keystone	1220
Maxell	CR1220

One of these brands must be installed.



Danger of explosion when replaced with wrong type of battery.
 Replace the battery only with a Lithium battery that has the same or equivalent type recommended by SECO Northern Europe GmbH.



Do not dispose of used CMOS batteries in domestic waste.
 Dispose of the battery according to the local regulations dealing with the disposal of these special materials (e. g. to the collecting points for disposal of batteries).

6.17 Replacement of the Internal Battery

The internal battery is placed as per figure below.
For replacement, the SD-card and the back cover have to be removed.
The device shall be opened by authorized and skilled personnel only.



Danger of electric hazard! First before opening, please make sure that the unit is completely disconnected from any power supply, direct or indirect. In order to remove the back cover all other connectors must be removed as well. Please make sure that the SD-card has been removed as it blocks the cover. Furthermore take care about the socket and connectors. Especially the micro USB connector might be damaged easily.

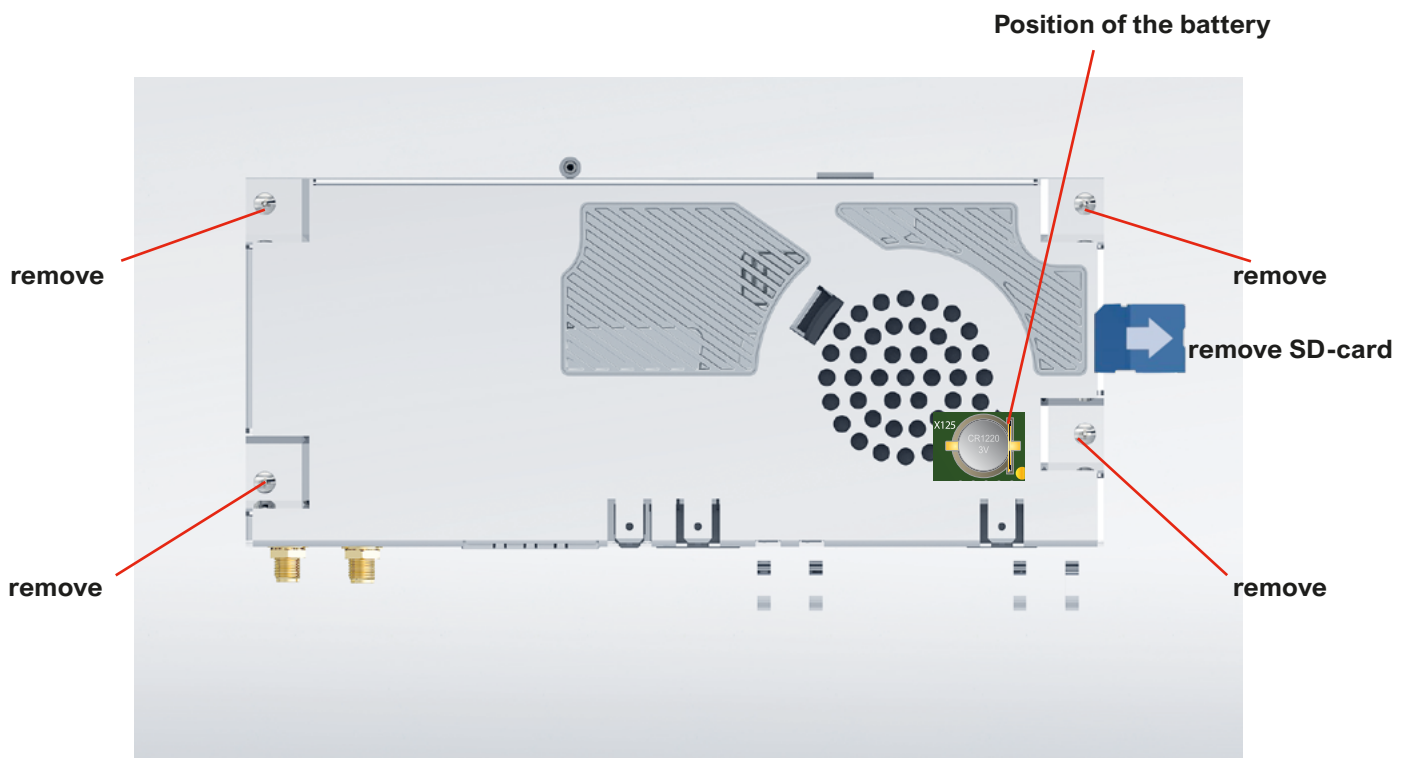

(Exemplary Illustration (cutout) backside)

Annex A: Technical Drawing

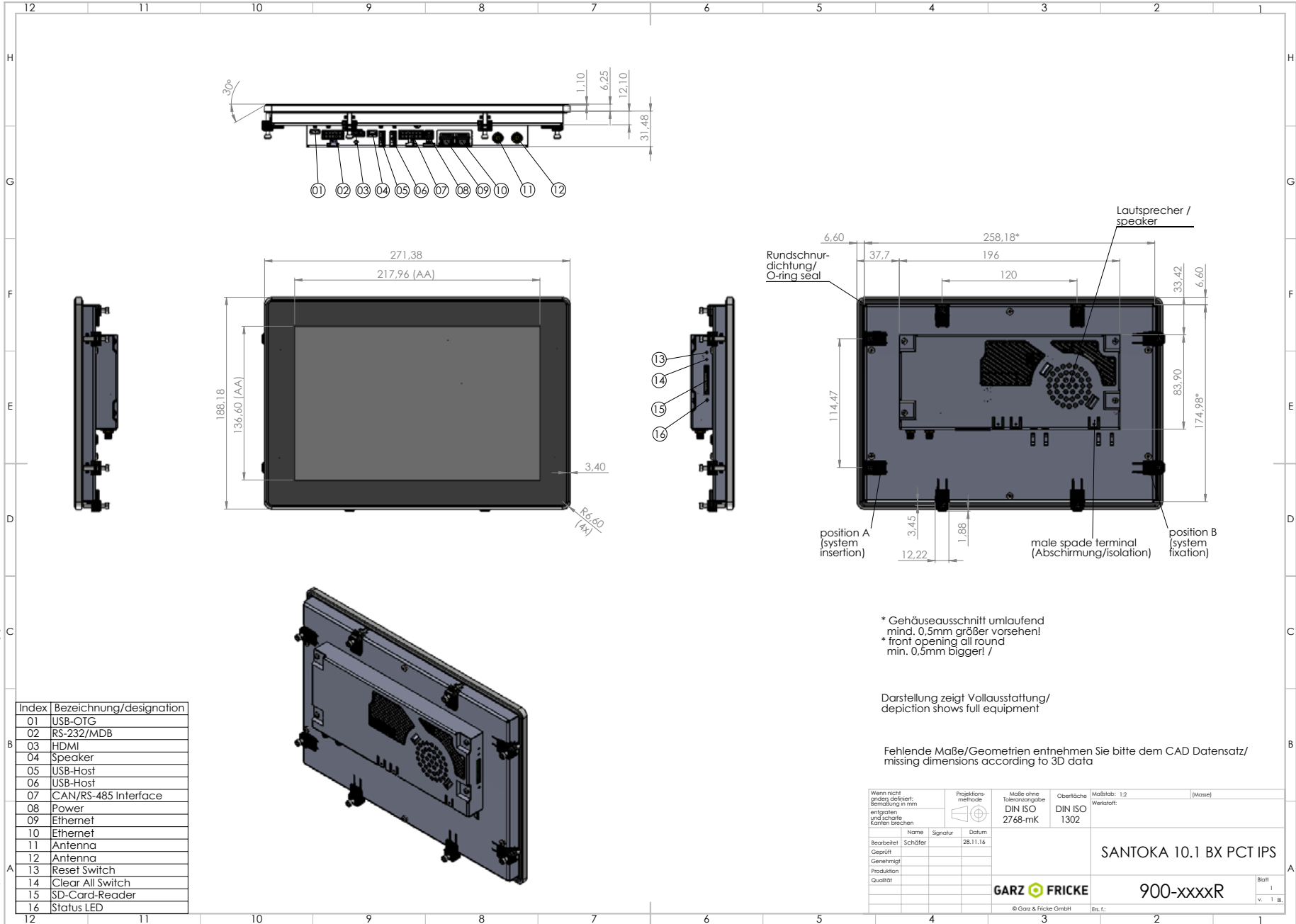

Annex B: Quality and Incoming Inspections

B-1 Display and Touch

Specification				Maximum amount display area	Maximum amount other area	Notes
Electrical defects (only displays)	Bright Dot	Minimum distance between dot and dot	L ≥ 5mm	2	-	One dot = one subpixel One pixel consists of three sub-pixels (dots), R, G and B.
	Dark Dot			3		
	Total Dot Defect			5		
Visual defects	Dot shape	D ≤ 0.25mm		ignored	ignored	Dot shape over all in display area and panel. It means Particle, Scratch, Bubble, Dent and others
		0.25 < D ≤ 0.5mm		3	< 200cm ² : 1 > 200cm ² : 3	
		D > 0.5mm		0	0	
	Line or spiral shape	W ≤ 0.07mm		ignored	ignored	Line shape over all in display area and panel. It means Particle, Scratch, Bubble, Dent and others
		0.07 < W ≤ 0.1mm, L ≤ 5mm		3	< 200cm ² : 1 > 200cm ² : 3	
		W > 0.1mm, L > 5mm		0	0	
	Chipped panel edges	≤ 0.7mm x ≤ 0.7mm		1		area ≤ 0.49mm ²
	Panel Crack			0		
	Bezel Deformation			0		not allowed if Deformation is obvious
	Bezel Oxidation			0		
	Bezel Scratch	L ≤ 10mm, W ≤ 0.1mm		3		
	Metal Squash Dent / Front Side			0		

Annex C: Evaluation criteria of standard display module

Evaluated Zone 1:

Areas in the immediate viewing area: dirt and dust enclosures / stains / striae / scratches from max. 500 µm (diameter) or 0.02 mm² (surface), 5 pcs. per dm² are permitted, but no clustering.

Evaluated Zone 2:

Surfaces that are concealed after installation: Dirt and dust enclosures / stains / striae / scratches from max. 2 mm (diameter) or 3 mm² (surface), 10 pcs per dm² are permitted.

Assessor:

trained, normal-sighted person

Viewing angle:

90 degrees to test object, no reflection

Lighting condition:

1000 LUX on test object

Viewing time:

max. 10 sec / dm²

Annex D: Hardware Revision Information

This document is applicable for all products listed below. Please note that customized variants might possibly not support all features listed herein. Additional features are documented in specific attachments.

Platform	Article Number	Marking on PCB
SANTOKA x1 12.1 BX PCT	tbd	0567 SANTOKA V1.2.2
SANTOKA x2 12.1 BX PCT	900-3578R	0567 SANTOKA V1.2.2
SANTOKA x2I 12.1 BX PCT	tbd	0567 SANTOKA V1.2.2

Hardware Revision	Changes	Marking on PCB
V1.0	initial release	0567 SANTOKA V1.0
V1.1	minor bug fixes	0567 SANTOKA V1.1
V1.2	Remove SDIO module; Added mini PCIe socket for Wifi/Bluetooth modules; Support for CPU variants Dual Plus and Quad Plus added; Changed battery type from CR2032 to CR1220; Minor changes	0567 SANTOKA V1.2
V1.2.1	PCIe control-signals connected; Minor changes	0567 SANTOKA V1.2.1
V1.2.2	Fix for Audio codec bug	0567 SANTOKA V1.2.2

Annex E: Assembly Options

E-1 Wi-Fi / Bluetooth

Some appliances require a wireless network connection. To be more flexible with regard to future Wi-Fi standards and regulations, we decided not to assemble this functionality directly onto the single-board-computer. We recommend an external USB or miniPCIe solution. Drivers for both versions will be included in the related operating systems. Please contact the support for information about supported modules.



Annex F: Guidelines and Standards

F-1 RoHS Declaration

Devices comply with the requirements of Directive 2011/65/EU of the European Parliament and of the Council of 8th June 2011 on the restriction of the use of certain hazardous substances in electrical and electronic equipment.

F-2 Supplier Declaration – Directive EG 1907/2006 REACH

SECO Northern Europe is manufacturer of electronic products, thus - in the sense of REACH - we are so called „downstream users“. The products we supply to you are solely non-chemical products (goods). Moreover and under normal and reasonably foreseeable circumstances of application, the goods supplied to you shall not release any substance. For that, SECO Northern Europe is neither obligatory for registration nor for the creation of material safety data sheet (MSDS).

From state of knowledge today our products contain no substances of very high concern from the current SVHC candidate list of the European Chemicals Agency in percentage >0,1.

We will immediately inform you in correspondence to REACH-Article 33 if any substance of content >0,1 percentage in our goods will be classified alarming by the ECHA. Based on the current status, however, we do not expect such an incidence.

F-3 UL Certification

Customers of SECO Northern Europe are attending on different markets. These markets are subjected to different UL certifications. Therefore SECO Northern Europe have no UL certification for their products.

To obtain UL certifications the product is designed to respect the following constraints:

- ▶ All electronic printed circuit boards are conform to UL standard
- ▶ Battery schematics meets the requirements of UL standard (please refer to chapter „**6.15 Battery-Holder (X125)**“)
- ▶ All wirings are designed with UL components
- ▶ The selected components on the markets are UL (List of UL relevant components is available at SECO Northern Europe (on request))

SECO Northern Europe do not guarantee to obtain UL certifications.

F-4 SECO Northern Europe Conformity Statement

SECO Northern Europe GmbH develops and distributes reliable, Arm®-based embedded solutions. We offer various solutions from computer-on-modules (COM) to single-board computers (SBC) and fully-assembled human machine interface (HMI) with pre-installed operating system, display and housing.

These solutions are offered exclusively as OEM products. They do not include any application software that is intended for the end user. Therefore, we do not make any EU declarations of conformity in the name of SECO Northern Europe GmbH and do not provide the products with the CE mark.

Our customers provide the products with application software and build them into an end-user device as part of an industrial production process. They identify themselves as a manufacturer by affixing a license plate with their company or brand name.

We are happy to assist our customers when they compile the necessary technical documentation for the EU Declaration of Conformity of the complete device. We provide e.g. Supplier declarations or RoHS certifications, issue EMC testing results and carry out safety / radio / SAR tests, etc.

Annex G: Common Documentation

G-1 Warranty hints



SECO Northern Europe embedded systems are subject to manufacturer's warranty as long as the products are handled with adequate care and caution and in accordance to this manual.

The period of guarantee starts from the date of shipment

The products are warranted against defects in material, quality and functionality within the warranty period.

During this period, the repair of the products is free of charge.

SECO Northern Europe will decide for repair or replacement at their own discretion.

If the product has been returned with or without prior notice and no failure or malfunction can be detected or the failure or malfunction is caused by inappropriate handling or the device has been returned after expiry of warranty period, SECO Northern Europe reserve the right to charge the user for repair or replacement.



The warranty does not cover defects caused by improper or inadequate installation, maintenance or handling by the user, unauthorized modification or misuse, operation outside the specification or non-compliance of this manual. In case of doubt, please contact the technical sales team prior to intended activity.

The warranty does also not cover any defects or damages of other equipment connected to the SECO Northern Europe product, faulty or not.

For warranty or repair service, please contact the technical sales team.

support.north@seco.com
rma.north@seco.com

G-2 Field of Application

The products covered by this document are designed and manufactured for the following applications (I). If you intend to use these products in applications as quoted in (II) we highly recommend a personal contact with our consultants and/or technical sales team.

(I) Recommended application areas for SECO Northern Europe embedded systems

Even for these applications, we recommend to get in contact with our technical sales team. We offer a wide range of support, even at an early stage of evaluation and/or design-in phase.

- ▶ Vending machines and gastronomy devices
- ▶ Industrial controllers and HMI systems
- ▶ Home automation and facility management
- ▶ Audiovisual equipment
- ▶ Instrumentation and measuring equipment

(II) Restricted application areas, prior consultation is mandatory to identify and meet the individual regulatory requirements

- ▶ Gas leak detectors
- ▶ Rescue and security equipment
- ▶ Safety devices
- ▶ Control and safety devices for airplanes, trains, automobiles and other transportation equipment
- ▶ Traffic control systems
- ▶ Control equipment for nuclear power industry
- ▶ Medical equipment related to life support etc.
- ▶ Gasoline stations and oil refineries

Annex H: Technical Support

Before contacting the SECO Northern Europe support team, please try to help yourself by the means of this manual or any other documentation provided by SECO Northern Europe or the related websites.

If this does not help at all, please feel free to contact us.

Our technicians and engineers will be glad to support you. Please note that beyond the support hours included the Starter Kit, various support packages are available. To keep the pure product cost at a reasonable level, we have to charge support and consulting services per effort.

Shipping Address:

SECO Northern Europe GmbH
Schlachthofstrasse 20
21079 Hamburg
Germany

Support Contact:

Phone: +49 (0) 40 / 791 899-200
Fax: +49 (0) 40 / 791 899-39
E-Mail: support.north@seco.com
URL: north.seco.com

Annex I: General Information

Trademarks and service marks

Names and logos in this document may be trademarks of their respective companies. In some cases descriptions for copyrighted products are not explicitly indicated as such. The absence of the trademark (™) and copyright (©) symbols does not imply that a product is not protected. Additionally, registered patents and trademarks are similarly not expressly indicated.

Drawings

All drawings, which are shown in this manual are schematic drawings. For exact technical drawings please refer to our sales team or product manager. All other product or service names are the property of their respective owners.

All rights reserved. Products subject to technical changes, improvements and misprints.
© 2022 SECO Northern Europe GmbH